

# AN79M00/AN79M00F Series

## 3-pin Negative Output Voltage Regulators (500mA Type)

### Overview

The AN79M00 and the AN79M00F series are 3-pin fixed negative output voltage regulators. Stabilized fixed output voltage is obtained from unstable DC input voltage without using any external components. 12 types of output voltage are available ; -5V, -5.2V, -6V, -7V, -8V, -9V, -10V, -12V, -15V, -18V, -20V and -24V. They can be used widely in power circuits with current capacitance up to 500mA.

### Features

- No external components
- Output voltage : -5V, -5.2V, -6V, -7V, -8V, -9V, -10V, -12V, -15V, -18V, -20V, -24V
- Short-circuit current limiting built-in
- Thermal overload protection built-in
- Output transistor safe area compensation

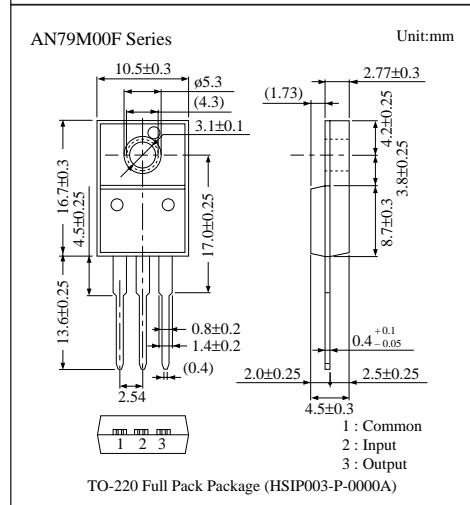
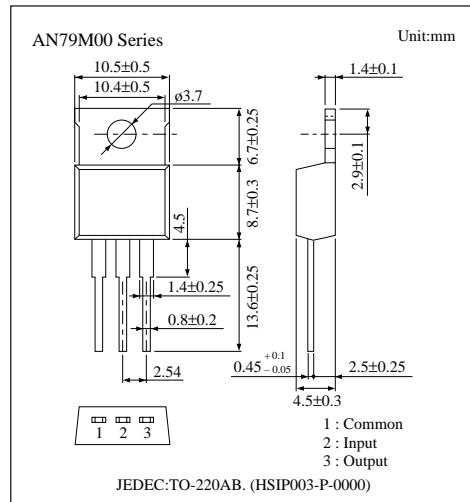

### Block Diagram

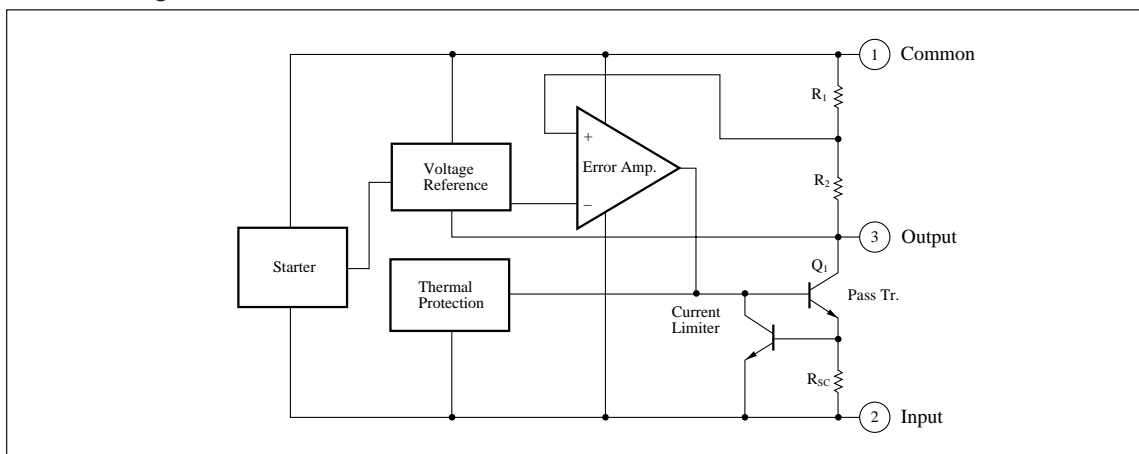

## ■ Absolute Maximum Ratings (Ta=25°C)

Parameter		Symbol	Rating	Unit
Input voltage		V <sub>I</sub>	-35 *1	V
			-40 *2	V
Power dissipation	AN79M00 Series	P <sub>D</sub>	15 *3	W
	AN79M00F Series		10.25 *3	
Operating ambient temperature		T <sub>opr</sub>	-20 to +80	°C
Storage temperature		T <sub>stg</sub>	-55 to +150	°C

\*1 AN79M05/F, AN79M52/F, AN79M06/F, AN79M07/F, AN79M08/F, AN79M09/F, AN79M10/F, AN79M12/F, AN79M15/F, AN79M18/F

\*2 AN79M20/F, AN79M24/F

\*3 Follow the derating curve. When T<sub>j</sub> exceeds 150°C, the internal circuit cuts off the output.

## ■ Electrical Characteristics (Ta=25°C)

• AN79M05/AN79M05F (-5V Type)

Parameter	Symbol	Condition	min	typ	max	Unit
Output voltage	V <sub>O</sub>	T <sub>j</sub> =25°C	-4.8	-5	-5.2	V
Output voltage tolerance	V <sub>O</sub>	V <sub>I</sub> =-7 to -25V, I <sub>O</sub> =5 to 350mA, P <sub>D</sub> ≤*	-4.75	—	-5.25	V
Line regulation	REG <sub>IN</sub>	V <sub>I</sub> =-7 to -25V, T <sub>j</sub> =25°C	—	3	50	mV
		V <sub>I</sub> =-8 to -18V, T <sub>j</sub> =25°C	—	1	30	mV
Load regulation	REG <sub>L</sub>	I <sub>O</sub> =5 to 500mA, T <sub>j</sub> =25°C	—	20	100	mV
		I <sub>O</sub> =5 to 350mA, T <sub>j</sub> =25°C	—	10	50	mV
Bias current	I <sub>Bias</sub>	T <sub>j</sub> =25°C	—	2	4	mA
Input bias current fluctuation	ΔI <sub>bias (IN)</sub>	V <sub>I</sub> =-8 to -25V, T <sub>j</sub> =25°C	—	—	0.8	mA
Load bias current fluctuation	ΔI <sub>bias (L)</sub>	I <sub>O</sub> =5 to 350mA, T <sub>j</sub> =25°C	—	—	0.4	mA
Output noise voltage	V <sub>no</sub>	f=10Hz to 100kHz, Ta=25°C	—	125	—	μV
Ripple rejection ratio	RR	V <sub>I</sub> =-8 to -18V, I <sub>O</sub> =100mA, f=120Hz, Ta=25°C	60	—	—	dB
Minimum input/output voltage difference	V <sub>DIF (min.)</sub>	T <sub>j</sub> =25°C	—	1.1	—	V
Output short circuit current	I <sub>O (Short)</sub>	V <sub>I</sub> =-35V, T <sub>j</sub> =25°C	—	50	—	mA
Peak output current	I <sub>O (peak)</sub>	T <sub>j</sub> =25°C	—	1000	—	mA
Output voltage temperature coefficient	ΔV <sub>O</sub> /Ta	I <sub>O</sub> =5mA, T <sub>j</sub> =0 to 125°C	—	-0.4	—	mV/°C

Note 1) The specified condition T<sub>j</sub>=25°C means that the test should be carried out with the test time so short (within 10ms) that the drift in characteristic value due to the rise in chip junction temperature can be ignored.

Note 2) When not specified, V<sub>I</sub>=-10V, I<sub>O</sub>=350mA, C<sub>I</sub>=2μF, C<sub>O</sub>=1μF and T<sub>j</sub>=0 to 125°C

\* AN79M05 : 15W, AN79M05F : 10.25W

## ■ Electrical Characteristics (Ta=25°C)

### • AN79M52/AN79M52F (-5.2V Type)

Parameter	Symbol	Condition	min	typ	max	Unit
Output voltage	$V_O$	$T_J=25^\circ\text{C}$	-5.0	-5.2	-5.4	V
Output voltage tolerance	$V_O$	$V_I=-7$ to $-25\text{V}$ , $I_O=5$ to $350\text{mA}$ , $P_D \leq *$	-4.94	—	-5.46	V
Line regulation	$\text{REG}_{\text{IN}}$	$V_I=-7$ to $-25\text{V}$ , $T_J=25^\circ\text{C}$	—	—	50	mV
		$V_I=-8$ to $-18\text{V}$ , $T_J=25^\circ\text{C}$	—	—	30	mV
Load regulation	$\text{REG}_{\text{L}}$	$I_O=5$ to $500\text{mA}$ , $T_J=25^\circ\text{C}$	—	—	100	mV
		$I_O=5$ to $350\text{mA}$ , $T_J=25^\circ\text{C}$	—	—	50	mV
Bias current	$I_{\text{Bias}}$	$T_J=25^\circ\text{C}$	—	2	4	mA
Input bias current fluctuation	$\Delta I_{\text{bias (IN)}}$	$V_I=-8$ to $-25\text{V}$ , $T_J=25^\circ\text{C}$	—	—	0.8	mA
Load bias current fluctuation	$\Delta I_{\text{bias (L)}}$	$I_O=5$ to $350\text{mA}$ , $T_J=25^\circ\text{C}$	—	—	0.4	mA
Output noise voltage	$V_{\text{no}}$	$f=10\text{Hz}$ to $100\text{kHz}$ , $T_a=25^\circ\text{C}$	—	130	—	$\mu\text{V}$
Ripple rejection ratio	RR	$V_I=-8$ to $-18\text{V}$ , $f=120\text{Hz}$ , $I_O=100\text{mA}$	60	—	—	dB
Minimum input/output voltage difference	$V_{\text{DIF (min.)}}$	$T_J=25^\circ\text{C}$	—	1.1	—	V
Output short circuit current	$I_{\text{O (Short)}}$	$V_I=-35\text{V}$ , $T_J=25^\circ\text{C}$	—	50	—	mA
Peak output current	$I_{\text{O (peak)}}$	$T_J=25^\circ\text{C}$	—	1000	—	mA
Output voltage temperature coefficient	$\Delta V_O/T_a$	$I_O=5\text{mA}$ , $T_J=0$ to $125^\circ\text{C}$	—	-0.4	—	$\text{mV}/^\circ\text{C}$

Note 1) The specified condition  $T_J=25^\circ\text{C}$  means that the test should be carried out with the test time so short (within 10ms) that the drift in characteristic value due to the rise in chip junction temperature can be ignored.

Note 2) When not specified,  $V_I=-10\text{V}$ ,  $I_O=350\text{mA}$ ,  $C_I=2\mu\text{F}$ ,  $C_O=1\mu\text{F}$  and  $T_J=0$  to  $125^\circ\text{C}$

\* AN79M52 : 15W, AN79M52F : 10.25W

### • AN79M06/AN79M06F (-6V Type)

Parameter	Symbol	Condition	min	typ	max	Unit
Output voltage	$V_O$	$T_J=25^\circ\text{C}$	-5.75	-6	-6.25	V
Output voltage tolerance	$V_O$	$V_I=-8$ to $-25\text{V}$ , $I_O=3$ to $350\text{mA}$ , $P_D \leq *$	-5.7	—	-6.3	V
Line regulation	$\text{REG}_{\text{IN}}$	$V_I=-8$ to $-25\text{V}$ , $T_J=25^\circ\text{C}$	—	5	60	mV
		$V_I=-9$ to $-19\text{V}$ , $T_J=25^\circ\text{C}$	—	1.5	40	mV
Load regulation	$\text{REG}_{\text{L}}$	$I_O=5$ to $500\text{mA}$ , $T_J=25^\circ\text{C}$	—	20	120	mV
		$I_O=5$ to $350\text{mA}$ , $T_J=25^\circ\text{C}$	—	10	60	mV
Bias current	$I_{\text{Bias}}$	$T_J=25^\circ\text{C}$	—	2	4	mA
Input bias current fluctuation	$\Delta I_{\text{bias (IN)}}$	$V_I=-9$ to $-25\text{V}$ , $T_J=25^\circ\text{C}$	—	—	0.8	mA
Load bias current fluctuation	$\Delta I_{\text{bias (L)}}$	$I_O=5$ to $350\text{mA}$ , $T_J=25^\circ\text{C}$	—	—	0.4	mA
Output noise voltage	$V_{\text{no}}$	$f=10\text{Hz}$ to $100\text{kHz}$ , $T_a=25^\circ\text{C}$	—	150	—	$\mu\text{V}$
Ripple rejection ratio	RR	$V_I=-9$ to $-19\text{V}$ , $I_O=100\text{mA}$ , $f=120\text{Hz}$ , $T_a=25^\circ\text{C}$	60	—	—	dB
Minimum input/output voltage difference	$V_{\text{DIF (min.)}}$	$T_J=25^\circ\text{C}$	—	1.1	—	V
Output short circuit current	$I_{\text{O (Short)}}$	$V_I=-35\text{V}$ , $T_J=25^\circ\text{C}$	—	50	—	mA
Peak output current	$I_{\text{O (peak)}}$	$T_J=25^\circ\text{C}$	—	1000	—	mA
Output voltage temperature coefficient	$\text{DV}_O/T_a$	$I_O=5\text{mA}$ , $T_J=0$ to $125^\circ\text{C}$	—	-0.4	—	$\text{mV}/^\circ\text{C}$

Note 1) The specified condition  $T_J=25^\circ\text{C}$  means that the test should be carried out with the test time so short (within 10ms) that the drift in characteristic value due to the rise in chip junction temperature can be ignored.

Note 2) When not specified,  $V_I=-11\text{V}$ ,  $I_O=350\text{mA}$ ,  $C_I=2\mu\text{F}$ ,  $C_O=1\mu\text{F}$  and  $T_J=0$  to  $125^\circ\text{C}$

\* AN79M06 : 15W, AN79M06F : 10.25W

## ■ Electrical Characteristics (Ta=25°C)

### • AN79M07/AN79M07F (-7V Type)

Parameter	Symbol	Condition	min	typ	max	Unit
Output voltage	$V_O$	$T_j=25^\circ\text{C}$	-6.7	-7	-7.3	V
Output voltage tolerance	$V_O$	$V_I=-9$ to $-25\text{V}$ , $I_O=5$ to $350\text{mA}$ , $P_D \leq *$	-6.65	—	-7.35	V
Line regulation	$\text{REG}_{\text{IN}}$	$V_I=-9$ to $-25\text{V}$ , $T_j=25^\circ\text{C}$	—	6	70	mV
		$V_I=-10$ to $-20\text{V}$ , $T_j=25^\circ\text{C}$	—	2	35	mV
Load regulation	$\text{REG}_{\text{L}}$	$I_O=5$ to $500\text{mA}$ , $T_j=25^\circ\text{C}$	—	20	140	mV
		$I_O=5$ to $350\text{mA}$ , $T_j=25^\circ\text{C}$	—	10	70	mV
Bias current	$I_{\text{Bias}}$	$T_j=25^\circ\text{C}$	—	2	4	mA
Input bias current fluctuation	$\Delta I_{\text{bias (IN)}}$	$V_I=-10$ to $-25\text{V}$ , $T_j=25^\circ\text{C}$	—	—	0.8	mA
Load bias current fluctuation	$\Delta I_{\text{bias (L)}}$	$I_O=5$ to $350\text{mA}$ , $T_j=25^\circ\text{C}$	—	—	0.4	mA
Output noise voltage	$V_{\text{no}}$	$f=10\text{Hz}$ to $100\text{kHz}$ , $T_a=25^\circ\text{C}$	—	175	—	$\mu\text{V}$
Ripple rejection ratio	RR	$V_I=-10$ to $-20\text{V}$ , $I_O=100\text{mA}$ , $f=120\text{Hz}$ , $T_a=25^\circ\text{C}$	59	—	—	dB
Minimum input/output voltage difference	$V_{\text{DIF (min.)}}$	$T_j=25^\circ\text{C}$	—	1.1	—	V
Output short circuit current	$I_{\text{O (Short)}}$	$V_I=-35\text{V}$ , $T_j=25^\circ\text{C}$	—	50	—	mA
Peak output current	$I_{\text{O (peak)}}$	$T_j=25^\circ\text{C}$	—	1000	—	mA
Output voltage temperature coefficient	$\Delta V_O/T_a$	$I_O=5\text{mA}$ , $T_j=0$ to $125^\circ\text{C}$	—	-0.5	—	$\text{mV}/^\circ\text{C}$

Note 1) The specified condition  $T_j=25^\circ\text{C}$  means that the test should be carried out with the test time so short (within 10ms) that the drift in characteristic value due to the rise in chip junction temperature can be ignored.

Note 2) When not specified,  $V_I=-12\text{V}$ ,  $I_O=350\text{mA}$ ,  $C_I=2\mu\text{F}$ ,  $C_O=1\mu\text{F}$  and  $T_j=0$  to  $125^\circ\text{C}$

\* AN79M07 : 15W, AN79M07F : 10.25W

### • AN79M08/AN79M08F (-8V Type)

Parameter	Symbol	Condition	min	typ	max	Unit
Output voltage	$V_O$	$T_j=25^\circ\text{C}$	-7.7	-8	-8.3	V
Output voltage tolerance	$V_O$	$V_I=-10.5$ to $-25\text{V}$ , $I_O=5$ to $350\text{mA}$ , $P_D \leq *$	-7.6	—	-8.4	V
Line regulation	$\text{REG}_{\text{IN}}$	$V_I=-10.5$ to $-25\text{V}$ , $T_j=25^\circ\text{C}$	—	6	80	mV
		$V_I=-11$ to $-21\text{V}$ , $T_j=25^\circ\text{C}$	—	2	40	mV
Load regulation	$\text{REG}_{\text{L}}$	$I_O=5$ to $500\text{mA}$ , $T_j=25^\circ\text{C}$	—	25	160	mV
		$I_O=5$ to $350\text{mA}$ , $T_j=25^\circ\text{C}$	—	10	80	mV
Bias current	$I_{\text{Bias}}$	$T_j=25^\circ\text{C}$	—	2	4	mA
Input bias current fluctuation	$\Delta I_{\text{bias (IN)}}$	$V_I=-10.5$ to $-25\text{V}$ , $T_j=25^\circ\text{C}$	—	—	0.8	mA
Load bias current fluctuation	$\Delta I_{\text{bias (L)}}$	$I_O=5$ to $350\text{mA}$ , $T_j=25^\circ\text{C}$	—	—	0.4	mA
Output noise voltage	$V_{\text{no}}$	$f=10\text{Hz}$ to $100\text{kHz}$ , $T_a=25^\circ\text{C}$	—	200	—	$\mu\text{V}$
Ripple rejection ratio	RR	$V_I=-11.5$ to $-21.5\text{V}$ , $I_O=100\text{mA}$ , $f=120\text{Hz}$ , $T_a=25^\circ\text{C}$	59	—	—	dB
Minimum input/output voltage difference	$V_{\text{DIF (min.)}}$	$T_j=25^\circ\text{C}$	—	1.1	—	V
Output short circuit current	$I_{\text{O (Short)}}$	$V_I=-35\text{V}$ , $T_j=25^\circ\text{C}$	—	50	—	mA
Peak output current	$I_{\text{O (peak)}}$	$T_j=25^\circ\text{C}$	—	1000	—	mA
Output voltage temperature coefficient	$\Delta V_O/T_a$	$I_O=5\text{mA}$ , $T_j=0$ to $125^\circ\text{C}$	—	-0.6	—	$\text{mV}/^\circ\text{C}$

Note 1) The specified condition  $T_j=25^\circ\text{C}$  means that the test should be carried out with the test time so short (within 10ms) that the drift in characteristic value due to the rise in chip junction temperature can be ignored.

Note 2) When not specified,  $V_I=-14\text{V}$ ,  $I_O=350\text{mA}$ ,  $C_I=2\mu\text{F}$ ,  $C_O=1\mu\text{F}$  and  $T_j=0$  to  $125^\circ\text{C}$

\* AN79M08 : 15W, AN79M08F : 10.25W

## ■ Electrical Characteristics (Ta=25°C)

### • AN79M09/AN79M09F (-9V Type)

Parameter	Symbol	Condition	min	typ	max	Unit
Output voltage	$V_O$	$T_j=25^\circ\text{C}$	-8.65	-9	-9.35	V
Output voltage tolerance	$V_O$	$V_I=-11.5$ to $-26\text{V}$ , $I_O=5$ to $350\text{mA}$ , $P_D \leq *$	-8.55	—	-9.45	V
Line regulation	REG <sub>IN</sub>	$V_I=-11.5$ to $-26\text{V}$ , $T_j=25^\circ\text{C}$	—	7	80	mV
		$V_I=-12$ to $-22\text{V}$ , $T_j=25^\circ\text{C}$	—	2	50	mV
Load regulation	REG <sub>L</sub>	$I_O=5$ to $500\text{mA}$ , $T_j=25^\circ\text{C}$	—	25	180	mV
		$I_O=5$ to $350\text{mA}$ , $T_j=25^\circ\text{C}$	—	10	90	mV
Bias current	$I_{\text{Bias}}$	$T_j=25^\circ\text{C}$	—	2	4	mA
Input bias current fluctuation	$\Delta I_{\text{bias (IN)}}$	$V_I=-11.5$ to $-26\text{V}$ , $T_j=25^\circ\text{C}$	—	—	0.8	mA
Load bias current fluctuation	$\Delta I_{\text{bias (L)}}$	$I_O=5$ to $350\text{mA}$ , $T_j=25^\circ\text{C}$	—	—	0.4	mA
Output noise voltage	$V_{\text{no}}$	$f=10\text{Hz}$ to $100\text{kHz}$ , $T_a=25^\circ\text{C}$	—	225	—	$\mu\text{V}$
Ripple rejection ratio	RR	$V_I=-12$ to $-22\text{V}$ , $I_O=100\text{mA}$ , $f=120\text{Hz}$ , $T_a=25^\circ\text{C}$	58	—	—	dB
Minimum input/output voltage difference	$V_{\text{DIF (min.)}}$	$T_j=25^\circ\text{C}$	—	1.1	—	V
Output short circuit current	$I_{\text{O (Short)}}$	$V_I=-35\text{V}$ , $T_j=25^\circ\text{C}$	—	50	—	mA
Peak output current	$I_{\text{O (peak)}}$	$T_j=25^\circ\text{C}$	—	1000	—	mA
Output voltage temperature coefficient	$\Delta V_O/T_a$	$I_O=5\text{mA}$ , $T_j=0$ to $125^\circ\text{C}$	—	-0.6	—	$\text{mV}/^\circ\text{C}$

Note 1) The specified condition  $T_j=25^\circ\text{C}$  means that the test should be carried out with the test time so short (within 10ms) that the drift in characteristic value due to the rise in chip junction temperature can be ignored.

Note 2) When not specified,  $V_I=-15\text{V}$ ,  $I_O=350\text{mA}$ ,  $C_I=2\mu\text{F}$ ,  $C_O=1\mu\text{F}$  and  $T_j=0$  to  $125^\circ\text{C}$

\* AN79M09 : 15W, AN79M09F : 10.25W

### • AN79M10/AN79M10F (-10V Type)

Parameter	Symbol	Condition	min	typ	max	Unit
Output voltage	$V_O$	$T_j=25^\circ\text{C}$	-9.6	-10	-10.4	V
Output voltage tolerance	$V_O$	$V_I=-12.5$ to $-27\text{V}$ , $I_O=5$ to $350\text{mA}$ , $P_D \leq *$	-9.5	—	-10.5	V
Line regulation	REG <sub>IN</sub>	$V_I=-12.5$ to $-27\text{V}$ , $T_j=25^\circ\text{C}$	—	7	80	mV
		$V_I=-13$ to $-23\text{V}$ , $T_j=25^\circ\text{C}$	—	2	50	mV
Load regulation	REG <sub>L</sub>	$I_O=5$ to $500\text{mA}$ , $T_j=25^\circ\text{C}$	—	25	200	mV
		$I_O=5$ to $350\text{mA}$ , $T_j=25^\circ\text{C}$	—	10	100	mV
Bias current	$I_{\text{Bias}}$	$T_j=25^\circ\text{C}$	—	2	4	mA
Input bias current fluctuation	$\Delta I_{\text{bias (IN)}}$	$V_I=-12.5$ to $-27\text{V}$ , $T_j=25^\circ\text{C}$	—	—	0.8	mA
Load bias current fluctuation	$\Delta I_{\text{bias (L)}}$	$I_O=5$ to $350\text{mA}$ , $T_j=25^\circ\text{C}$	—	—	0.4	mA
Output noise voltage	$V_{\text{no}}$	$f=10\text{Hz}$ to $100\text{kHz}$ , $T_a=25^\circ\text{C}$	—	250	—	$\mu\text{V}$
Ripple rejection ratio	RR	$V_I=-13$ to $-23\text{V}$ , $I_O=100\text{mA}$ , $f=120\text{Hz}$ , $T_a=25^\circ\text{C}$	58	—	—	dB
Minimum input/output voltage difference	$V_{\text{DIF (min.)}}$	$T_j=25^\circ\text{C}$	—	1.1	—	V
Output short circuit current	$I_{\text{O (Short)}}$	$V_I=-35\text{V}$ , $T_j=25^\circ\text{C}$	—	50	—	mA
Peak output current	$I_{\text{O (peak)}}$	$T_j=25^\circ\text{C}$	—	1000	—	mA
Output voltage temperature coefficient	$\Delta V_O/T_a$	$I_O=5\text{mA}$ , $T_j=0$ to $125^\circ\text{C}$	—	-0.7	—	$\text{mV}/^\circ\text{C}$

Note 1) The specified condition  $T_j=25^\circ\text{C}$  means that the test should be carried out with the test time so short (within 10ms) that the drift in characteristic value due to the rise in chip junction temperature can be ignored.

Note 2) When not specified,  $V_I=-16\text{V}$ ,  $I_O=350\text{mA}$ ,  $C_I=2\mu\text{F}$ ,  $C_O=1\mu\text{F}$  and  $T_j=0$  to  $125^\circ\text{C}$

\* AN79M10 : 15W, AN79M10F : 10.25W

## ■ Electrical Characteristics (Ta=25°C)

### • AN79M12/AN79M12F (-12V Type)

Parameter	Symbol	Condition	min	typ	max	Unit
Output voltage	V <sub>O</sub>	T <sub>j</sub> =25°C	-11.5	-12	-12.5	V
Output voltage tolerance	V <sub>O</sub>	V <sub>I</sub> =-14.5 to -30V, I <sub>O</sub> =5 to 350mA, P <sub>D</sub> ≤*	-11.4	—	-12.6	V
Line regulation	REG <sub>IN</sub>	V <sub>I</sub> =-14.5 to -30V, T <sub>j</sub> =25°C	—	8	80	mV
		V <sub>I</sub> =-15 to -25V, T <sub>j</sub> =25°C	—	2	50	mV
Load regulation	REG <sub>L</sub>	I <sub>O</sub> =5 to 500mA, T <sub>j</sub> =25°C	—	25	240	mV
		I <sub>O</sub> =5 to 350mA, T <sub>j</sub> =25°C	—	10	120	mV
Bias current	I <sub>Bias</sub>	T <sub>j</sub> =25°C	—	2	4	mA
Input bias current fluctuation	ΔI <sub>bias (IN)</sub>	V <sub>I</sub> =-14.5 to -30V, T <sub>j</sub> =25°C	—	—	0.8	mA
Load bias current fluctuation	ΔI <sub>bias (L)</sub>	I <sub>O</sub> =5 to 350mA, T <sub>j</sub> =25°C	—	—	0.4	mA
Output noise voltage	V <sub>no</sub>	f=10Hz to 100kHz, Ta=25°C	—	300	—	μV
Ripple rejection ratio	RR	V <sub>I</sub> =-15 to -25V, I <sub>O</sub> =100mA, f=120Hz, Ta=25°C	57	—	—	dB
Minimum input/output voltage difference	V <sub>DIF (min.)</sub>	T <sub>j</sub> =25°C	—	1.1	—	V
Output short circuit current	I <sub>O (Short)</sub>	V <sub>I</sub> =-35V, T <sub>j</sub> =25°C	—	50	—	mA
Peak output current	I <sub>O (peak)</sub>	T <sub>j</sub> =25°C	—	1000	—	mA
Output voltage temperature coefficient	ΔV <sub>O</sub> /Ta	I <sub>O</sub> =5mA, T <sub>j</sub> =0 to 125°C	—	-0.8	—	mV/°C

Note 1) The specified condition T<sub>j</sub>=25°C means that the test should be carried out with the test time so short (within 10ms) that the drift in characteristic value due to the rise in chip junction temperature can be ignored.

Note 2) When not specified, V<sub>I</sub>=-19V, I<sub>O</sub>=350mA, C<sub>I</sub>=2μF, C<sub>O</sub>=1μF and T<sub>j</sub>=0 to 125°C

\* AN79M12 : 15W, AN79M12F : 10.25W

### • AN79M15/AN79M15F (-15V Type)

Parameter	Symbol	Condition	min	typ	max	Unit
Output voltage	V <sub>O</sub>	T <sub>j</sub> =25°C	-14.4	-15	-15.6	V
Output voltage tolerance	V <sub>O</sub>	V <sub>I</sub> =-17.5 to -30V, I <sub>O</sub> =5 to 350mA, P <sub>D</sub> ≤*	-14.25	—	-15.75	V
Line regulation	REG <sub>IN</sub>	V <sub>I</sub> =-17.5 to -30V, T <sub>j</sub> =25°C	—	10	80	mV
		V <sub>I</sub> =-18 to -28V, T <sub>j</sub> =25°C	—	3	50	mV
Load regulation	REG <sub>L</sub>	I <sub>O</sub> =5 to 500mA, T <sub>j</sub> =25°C	—	25	240	mV
		I <sub>O</sub> =5 to 350mA, T <sub>j</sub> =25°C	—	10	120	mV
Bias current	I <sub>Bias</sub>	T <sub>j</sub> =25°C	—	2	4	mA
Input bias current fluctuation	ΔI <sub>bias (IN)</sub>	V <sub>I</sub> =-17.5 to -30V, T <sub>j</sub> =25°C	—	—	0.8	mA
Load bias current fluctuation	ΔI <sub>bias (L)</sub>	I <sub>O</sub> =5 to 350mA, T <sub>j</sub> =25°C	—	—	0.4	mA
Output noise voltage	V <sub>no</sub>	f=10Hz to 100kHz, Ta=25°C	—	375	—	μV
Ripple rejection ratio	RR	V <sub>I</sub> =-18 to -28V, I <sub>O</sub> =100mA, f=120Hz, Ta=25°C	56	—	—	dB
Minimum input/output voltage difference	V <sub>DIF (min.)</sub>	T <sub>j</sub> =25°C	—	1.1	—	V
Output short circuit current	I <sub>O (Short)</sub>	V <sub>I</sub> =-35V, T <sub>j</sub> =25°C	—	50	—	mA
Peak output current	I <sub>O (peak)</sub>	T <sub>j</sub> =25°C	—	1000	—	mA
Output voltage temperature coefficient	ΔV <sub>O</sub> /Ta	I <sub>O</sub> =5mA, T <sub>j</sub> =0 to 125°C	—	-0.9	—	mV/°C

Note 1) The specified condition T<sub>j</sub>=25°C means that the test should be carried out with the test time so short (within 10ms) that the drift in characteristic value due to the rise in chip junction temperature can be ignored.

Note 2) When not specified, V<sub>I</sub>=-23V, I<sub>O</sub>=350mA, C<sub>I</sub>=2μF, C<sub>O</sub>=1μF and T<sub>j</sub>=0 to 125°C

\* AN79M15 : 15W, AN79M15F : 10.25W

## ■ Electrical Characteristics (Ta=25°C)

### • AN79M18/AN79M18F (-18V Type)

Parameter	Symbol	Condition	min	typ	max	Unit
Output voltage	V <sub>O</sub>	T <sub>j</sub> =25°C	-17.3	-18	-18.7	V
Output voltage tolerance	V <sub>O</sub>	V <sub>I</sub> =-21 to -33V, I <sub>O</sub> =5 to 350mA, P <sub>D</sub> ≤*	-17.1	—	-18.9	V
Line regulation	REG <sub>IN</sub>	V <sub>I</sub> =-21 to -33V, T <sub>j</sub> =25°C	—	10	80	mV
		V <sub>I</sub> =-22 to -32V, T <sub>j</sub> =25°C	—	5	50	mV
Load regulation	REG <sub>L</sub>	I <sub>O</sub> =5 to 500mA, T <sub>j</sub> =25°C	—	30	300	mV
		I <sub>O</sub> =5 to 350mA, T <sub>j</sub> =25°C	—	10	150	mV
Bias current	I <sub>Bias</sub>	T <sub>j</sub> =25°C	—	2	4	mA
Input bias current fluctuation	ΔI <sub>bias (IN)</sub>	V <sub>I</sub> =-21 to -33V, T <sub>j</sub> =25°C	—	—	0.8	mA
Load bias current fluctuation	ΔI <sub>bias (L)</sub>	I <sub>O</sub> =5 to 350mA, T <sub>j</sub> =25°C	—	—	0.4	mA
Output noise voltage	V <sub>no</sub>	f=10Hz to 100kHz, Ta=25°C	—	450	—	μV
Ripple rejection ratio	RR	V <sub>I</sub> =-22 to -32V, I <sub>O</sub> =100mA, f=120Hz, Ta=25°C	55	—	—	dB
Minimum input/output voltage difference	V <sub>DIF (min.)</sub>	T <sub>j</sub> =25°C	—	1.1	—	V
Output short circuit current	I <sub>O (Short)</sub>	V <sub>I</sub> =-35V, T <sub>j</sub> =25°C	—	50	—	mA
Peak output current	I <sub>O (peak)</sub>	T <sub>j</sub> =25°C	—	1000	—	mA
Output voltage temperature coefficient	ΔV <sub>O</sub> /Ta	I <sub>O</sub> =5mA, T <sub>j</sub> =0 to 125°C	—	-1	—	mV/°C

Note 1) The specified condition T<sub>j</sub>=25°C means that the test should be carried out with the test time so short (within 10ms) that the drift in characteristic value due to the rise in chip junction temperature can be ignored.

Note 2) When not specified, V<sub>I</sub>=-27V, I<sub>O</sub>=350mA, C<sub>I</sub>=2μF, C<sub>O</sub>=1μF and T<sub>j</sub>=0 to 125°C

\* AN79M18 : 15W, AN79M18F : 10.25W

### • AN79M20/AN79M20F (-20V Type)

Parameter	Symbol	Condition	min	typ	max	Unit
Output voltage	V <sub>O</sub>	T <sub>j</sub> =25°C	-19.2	-20	-20.8	V
Output voltage tolerance	V <sub>O</sub>	V <sub>I</sub> =-23 to -35V, I <sub>O</sub> =5 to 350mA, P <sub>D</sub> ≤*	-19	—	-21	V
Line regulation	REG <sub>IN</sub>	V <sub>I</sub> =-23 to -35V, T <sub>j</sub> =25°C	—	10	80	mV
		V <sub>I</sub> =-24 to -34V, T <sub>j</sub> =25°C	—	5	50	mV
Load regulation	REG <sub>L</sub>	I <sub>O</sub> =5 to 500mA, T <sub>j</sub> =25°C	—	30	300	mV
		I <sub>O</sub> =5 to 350mA, T <sub>j</sub> =25°C	—	10	150	mV
Bias current	I <sub>Bias</sub>	T <sub>j</sub> =25°C	—	2	4	mA
Input bias current fluctuation	ΔI <sub>bias (IN)</sub>	V <sub>I</sub> =-23 to -35V, T <sub>j</sub> =25°C	—	—	0.8	mA
Load bias current fluctuation	ΔI <sub>bias (L)</sub>	I <sub>O</sub> =5 to 350mA, T <sub>j</sub> =25°C	—	—	0.4	mA
Output noise voltage	V <sub>no</sub>	f=10Hz to 100kHz, Ta=25°C	—	500	—	μV
Ripple rejection ratio	RR	V <sub>I</sub> =-24 to -34V, I <sub>O</sub> =100mA, f=120Hz, Ta=25°C	54	—	—	dB
Minimum input/output voltage difference	V <sub>DIF (min.)</sub>	T <sub>j</sub> =25°C	—	1.1	—	V
Output short circuit current	I <sub>O (Short)</sub>	V <sub>I</sub> =-35V, T <sub>j</sub> =25°C	—	50	—	mA
Peak output current	I <sub>O (peak)</sub>	T <sub>j</sub> =25°C	—	1000	—	mA
Output voltage temperature coefficient	ΔV <sub>O</sub> /Ta	I <sub>O</sub> =5mA, T <sub>j</sub> =0 to 125°C	—	-1	—	mV/°C

Note 1) The specified condition T<sub>j</sub>=25°C means that the test should be carried out with the test time so short (within 10ms) that the drift in characteristic value due to the rise in chip junction temperature can be ignored.

Note 2) When not specified, V<sub>I</sub>=-29V, I<sub>O</sub>=350mA, C<sub>I</sub>=2μF, C<sub>O</sub>=1μF and T<sub>j</sub>=0 to 125°C

\* AN79M20 : 15W, AN79M20F : 10.25W

## ■ Electrical Characteristics (Ta=25°C)

• AN79M24/AN79M24F (-24V Type)

Parameter	Symbol	Condition	min	typ	max	Unit
Output voltage	$V_O$	$T_j=25^\circ\text{C}$	-23	-24	-25	V
Output voltage tolerance	$V_O$	$V_I=-27$ to $-38\text{V}$ , $I_O=5$ to $350\text{mA}$ , $P_D \leq *$	-22.8	—	-25.2	V
Line regulation	$\text{REG}_{\text{IN}}$	$V_I=-27$ to $-38\text{V}$ , $T_j=25^\circ\text{C}$	—	10	80	mV
		$V_I=-27$ to $-37\text{V}$ , $T_j=25^\circ\text{C}$	—	5	70	mV
Load regulation	$\text{REG}_{\text{L}}$	$I_O=5$ to $500\text{mA}$ , $T_j=25^\circ\text{C}$	—	30	300	mV
		$I_O=5$ to $350\text{mA}$ , $T_j=25^\circ\text{C}$	—	10	150	mV
Bias current	$I_{\text{Bias}}$	$T_j=25^\circ\text{C}$	—	2	4	mA
Input bias current fluctuation	$\Delta I_{\text{bias (IN)}}$	$V_I=-27$ to $-38\text{V}$ , $T_j=25^\circ\text{C}$	—	—	0.8	mA
Load bias current fluctuation	$\Delta I_{\text{bias (L)}}$	$I_O=5$ to $350\text{mA}$ , $T_j=25^\circ\text{C}$	—	—	0.4	mA
Output noise voltage	$V_{\text{no}}$	$f=10\text{Hz}$ to $100\text{kHz}$ , $T_a=25^\circ\text{C}$	—	600	—	$\mu\text{V}$
Ripple rejection ratio	RR	$V_I=-28$ to $-38\text{V}$ , $I_O=100\text{mA}$ , $f=120\text{Hz}$ , $T_a=25^\circ\text{C}$	54	—	—	dB
Minimum input/output voltage difference	$V_{\text{DIF (min.)}}$	$T_j=25^\circ\text{C}$	—	1.1	—	V
Output short circuit current	$I_{\text{O (Short)}}$	$V_I=-35\text{V}$ , $T_j=25^\circ\text{C}$	—	50	—	mA
Peak output current	$I_{\text{O (peak)}}$	$T_j=25^\circ\text{C}$	—	1000	—	mA
Output voltage temperature coefficient	$\Delta V_O/T_a$	$I_O=5\text{mA}$ , $T_j=0$ to $125^\circ\text{C}$	—	-1	—	$\text{mV}/^\circ\text{C}$

Note 1) The specified condition  $T_j=25^\circ\text{C}$  means that the test should be carried out with the test time so short (within 10ms) that the drift in characteristic value due to the rise in chip junction temperature can be ignored.

Note 2) When not specified,  $V_I=-33\text{V}$ ,  $I_O=350\text{mA}$ ,  $C_I=2\mu\text{F}$ ,  $C_O=1\mu\text{F}$  and  $T_j=0$  to  $125^\circ\text{C}$

\* AN79M24 : 15W, AN79M24F : 10.25W



## Characteristic Curve

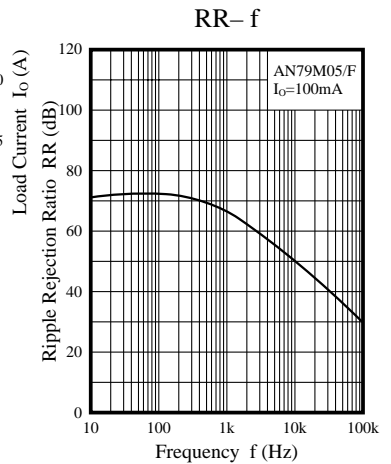
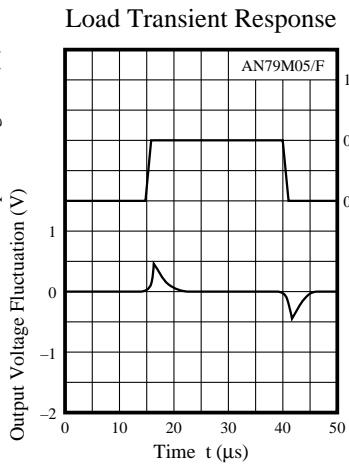
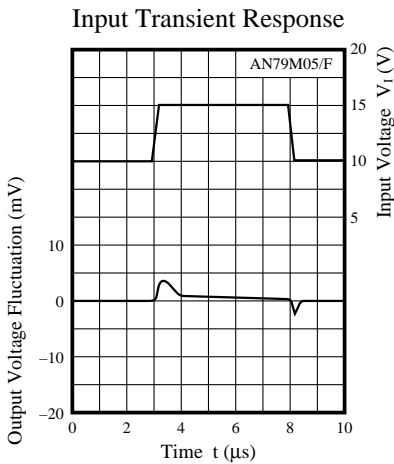
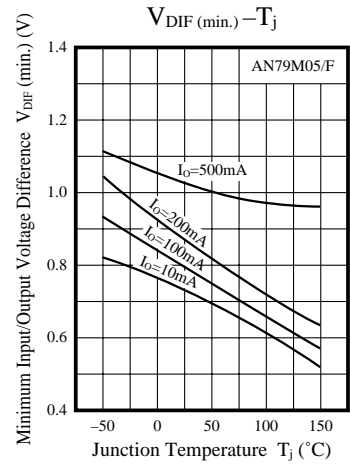
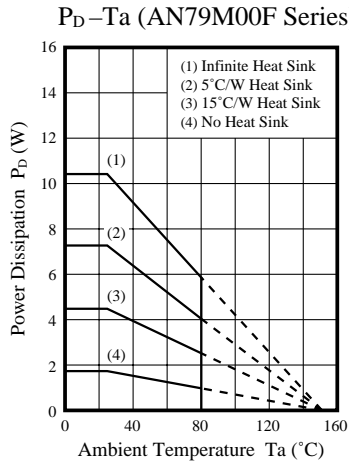
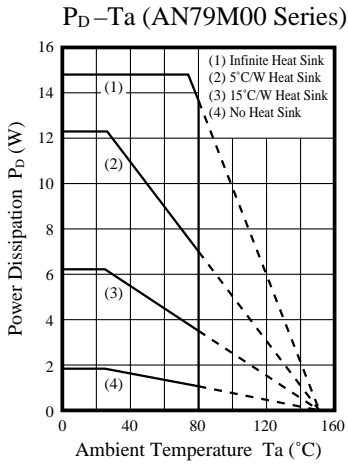

## Basic Regulator Circuit

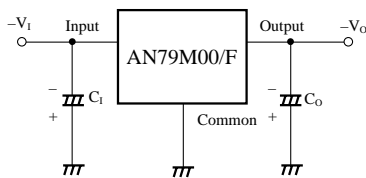

$C_1$  is connected when the input line is long.  $2\mu\text{F}$   
 $C_o$  improves the transient Response.  $1\mu\text{F}$

## Application Circuit

